

Living Catalogue

The new range of frame screens
for home cinema



SCREENLINE
the screen makes the difference

Living

Living is the latest line of frame screens for home cinema. The frame is designed for projection with traditional installation or ultra short throw video projectors.



Living

Living
curved

Living velvet

Living velvet
curved



From 200 cm to 450 cm of base

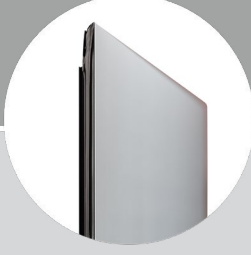
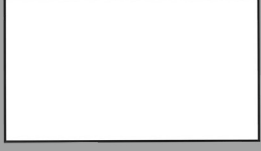

Living thin

Living thin
curved

Living full
vision

Living full
vision curved

Living

Living curved

From 200 cm to 450 cm of base

16:9

16:10

4:3

10 cm black frame

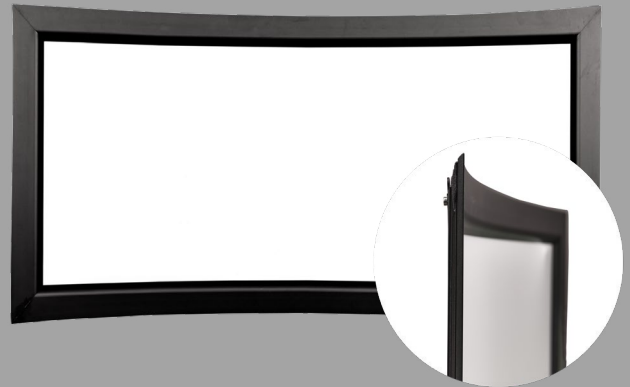

10 cm black borders. Available in the traditional version or curved.

It features a profile with an inward 45° angle designed for videoprojection with ultra-short optics which also guarantees a perfect flatness of the fabric placed on the back of the frame.

Living velvet

Living velvet curved

From 200 cm to 450 cm of base

16:9

16:10

4:3

10 cm black velvet frame

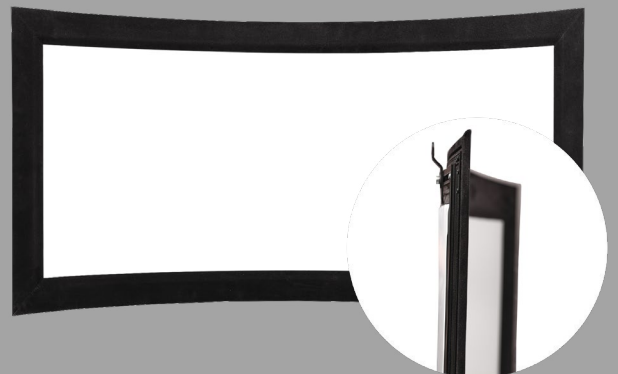
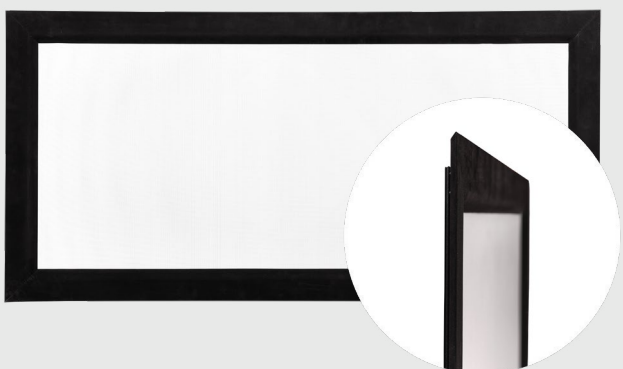

10 cm black velvet borders. Available in the traditional version or curved.

The smooth borders with black velvet finish absorb any possible overlapping of the projected image.

Living thin

Living thin curved

From 200 cm to 450 cm of base

16:9

16:10

4:3

5 mm black frame

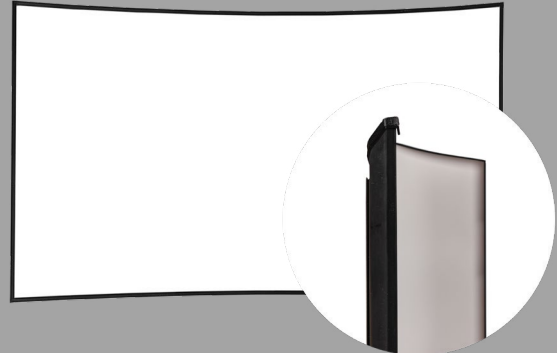
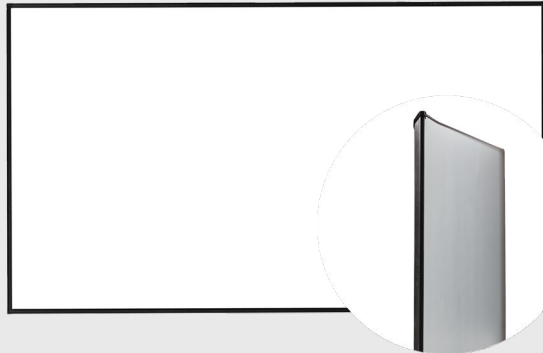

5 mm black borders. Available in the traditional version or curved.

The trendy screen in modern home cinema with 5 mm thin frame. This model, paired with high contrast RADIANCE fabrics specific for video projection in normally lit environments, represents the market trend and the maximum evolution of modern home cinema.

Living full vision

Living full vision curved

From 200 cm to 450 cm of base

16:9

16:10

4:3

Full vision

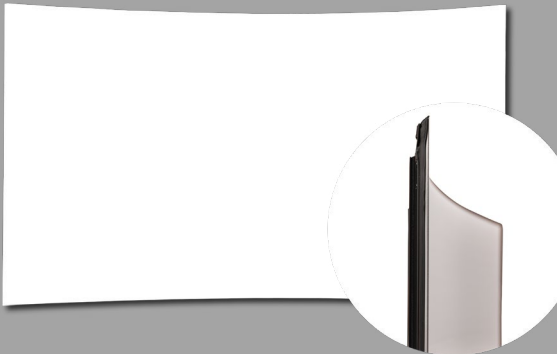
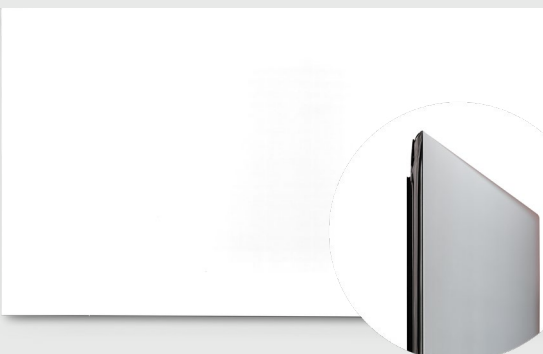

No black borders. Available in the traditional version or curved.

Elegant and minimal, it becomes a fine piece of furniture in any living space and design room. It becomes total white or shimmer grey according to the installed fabric.

Technical features

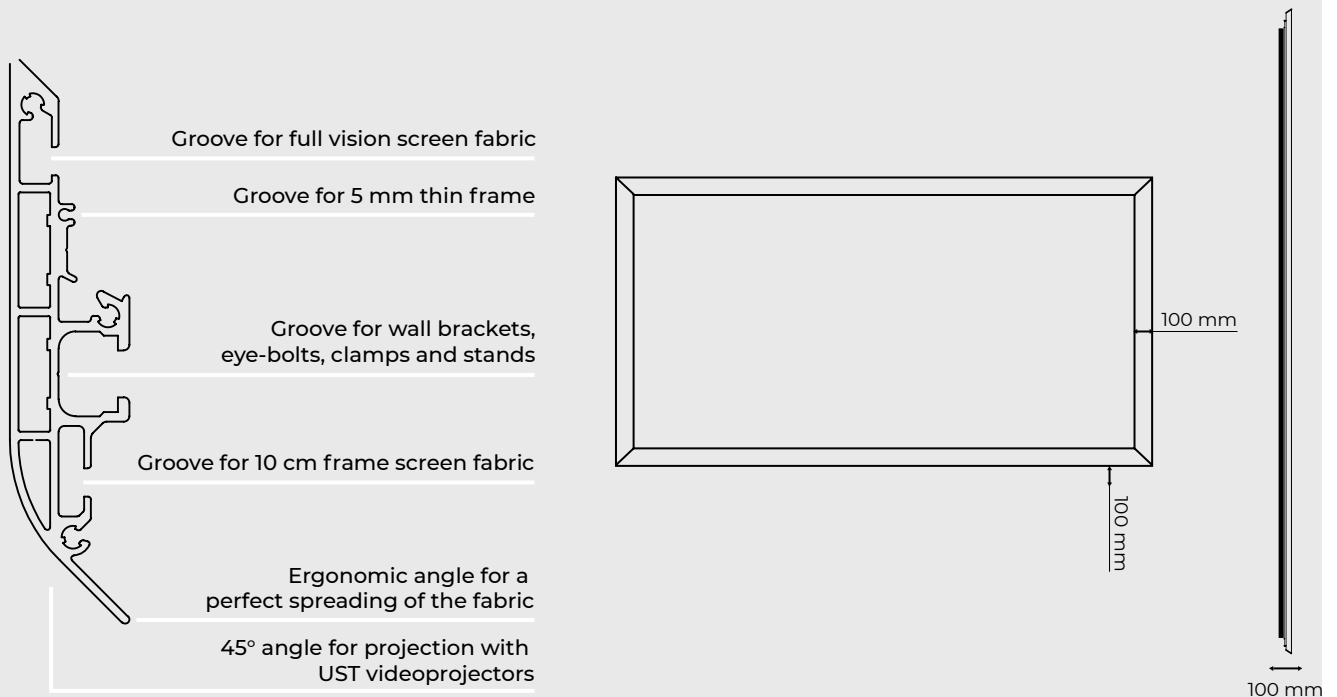

Special fabrics

All LIVING frame screens feature a wide range of traditional PVC fabrics.

This model, combined with the **high-contrast RADIANCE fabrics** specific for video projection in normally lit environments, represents the market trend and the maximum evolution of modern home cinema.

It is important to focus on the **RADIANCE fabric line** dedicated to the projections in ambient light, which perfectly complete the performances of LIVING screens.



Radiance 0.6

Gain	Color front	Color rear	Thickness	Bulk height	Contrast	Brightness	Sound transmitting
0.6	Silver	Silver	500 micron	2300 micron	++	+	×



Radiance 0.6 Microperforated

Gain	Color front	Color rear	Thickness	Bulk height	Contrast	Brightness	Sound transmitting
0.6	Silver	Silver	500 micron	2300 micron	++	+	✓



Radiance 0.8

Gain	Color front	Color rear	Thickness	Bulk height	Contrast	Brightness	Sound transmitting
0.8	Silver gray	Silver gray	400 micron	2100 micron	++	++	×

Accessories

Wall Brackets

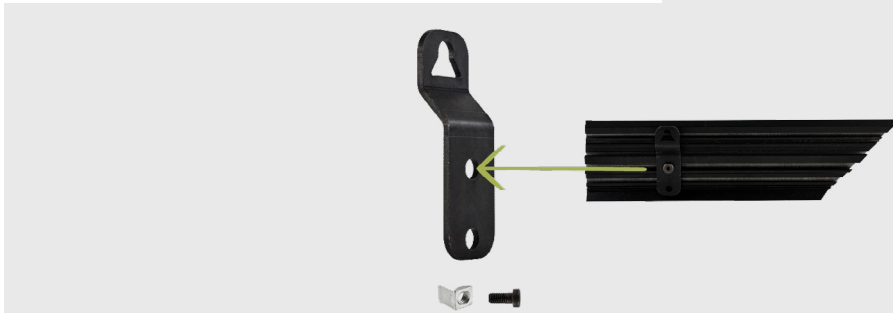

Hanging Brackets

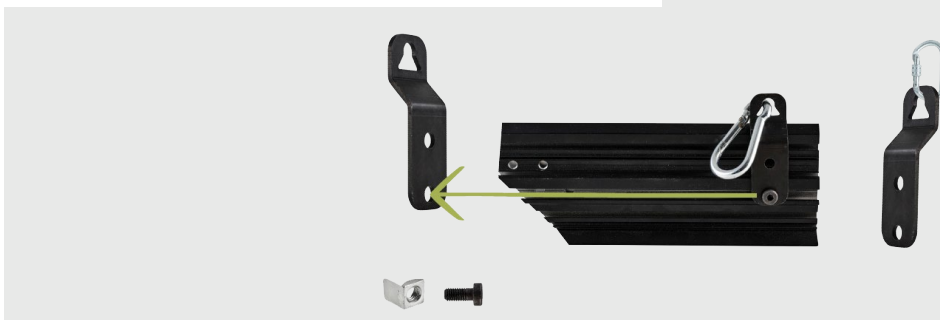

Easy Fabric Installation

Living and Living Velvet

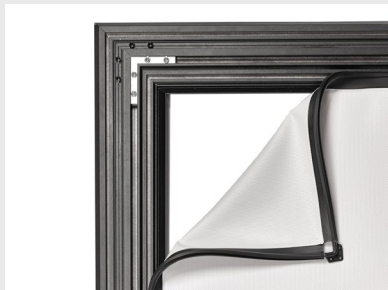

Living thin

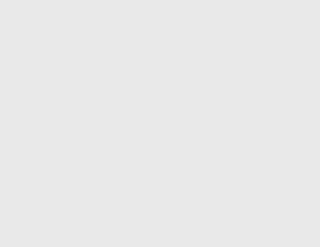
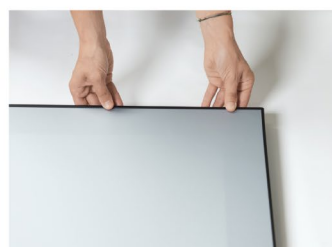
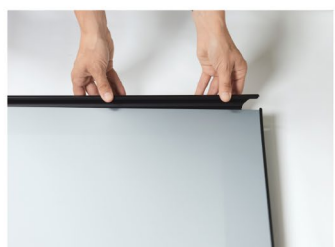
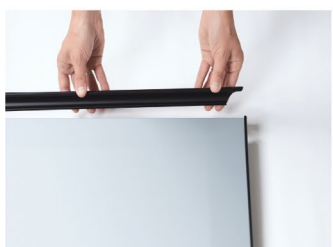

Living full vision



Improved version

- Performance and vigorous profile that allows to reach viewing area base up to 450 m.
- The ergonomical shape of the frame offers a physiological tension of the fabric.
- 45 ° internal angle for a perfect video projection with ultra short throw.
- Great versatility of wall, ceiling installation with truss and wall brackets.
- Recommended in combination with one of the specific high contrast RADIANCE fabrics for video projection in ambient light.









Screenline S.R.L

📍 38060 Besenello (TN)
Via Nazionale, 1/n - 1/u

☎ +39 0464 830003

✉ info@screenline.it

🌐 www.screenline.it

SCREENLINE
the screen makes the difference

Screen designers and manufacturers of Italy

